

Grease Nipple
A-MT6x1 Type (Back Side)

>Description
SW Special Wheel
SW-50-I Type
Unit = mm

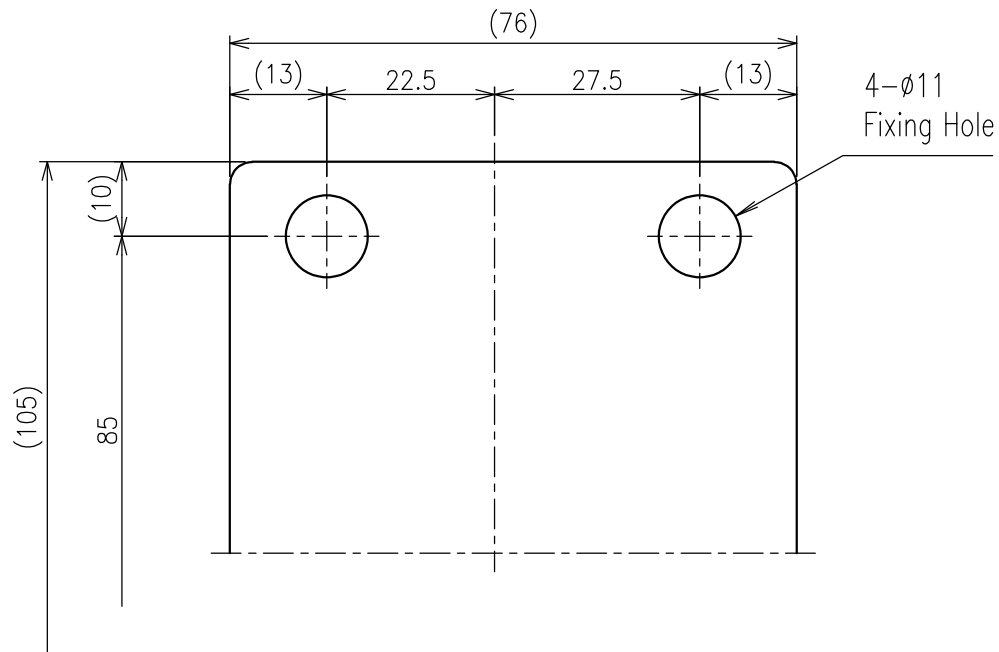

4- ϕ 11
Fixing Hole

>Specification
Product Weight = 1.1kg
Load Capacity = 100kgf

Head = S45C (Hardend)
Body = FC250